

2. Sewing the pleating tape onto the curtain.

Sew the Hinno 'Curve pleating tape onto the curtain as shown, making sure it is flush with the upper edge of the curtain.

The pleating tape is available with two different heights:

- Choose the pleating tape with a height of **3.8 cm** for light-weight materials and smaller curtain heights.
- Always use the **7.8 cm** pleating tape for heavier materials and normal curtain heights.

NOTE: Do not fold the Hinno 'Curve pleating tape; this will ensure the waves remain even and smooth.

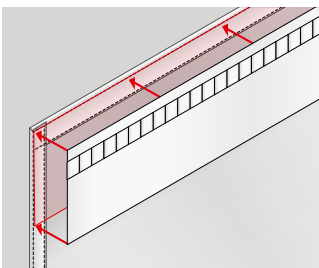

3. Inserting the hooks.

- 3.1 Insert the first hook (HH 9) into the 4th loop in the pleating tape by sliding it back-to-front into the loop from the bottom (a) and then turning it full circle (b).

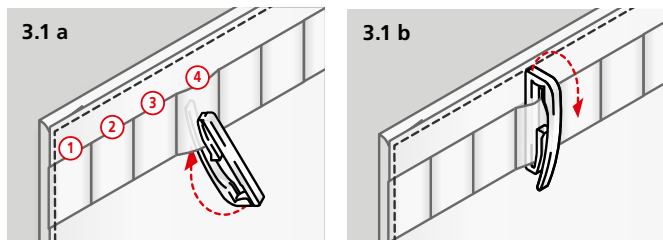

- 3.2 Using the Hinno 'Curve ruler. Each loop on the pleating tape is exactly one centimetre wide. Use the ruler to position the other hooks in the right loops at the right distance (in accordance with the wave length you have chosen). If you work accurately, the last hook should fit into the 4th loop from the end of the pleating tape. Positioning the first and last hooks in the 4th loop from each end allows the curtain material to hide the outermost gliders of the 'Curve system so they cannot be seen when the system is in place.

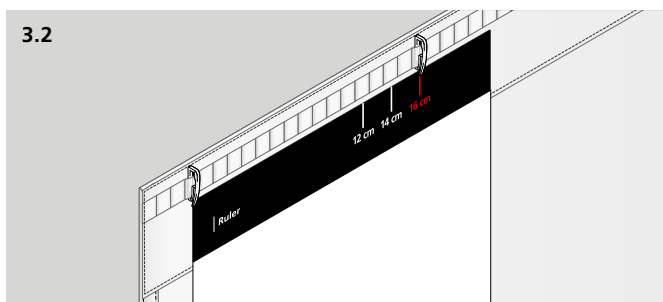

4. Mounting the 'Curve cord.

Click the outermost 'Clic glider into the curtain track. Stretch the 'Curve cord slightly and click the next 'Clic glider in. **NOTE:** When clicking the glider in, make sure that the cord mounting on the 'Clic glider is always facing in the same direction! Keep going until the whole 'Curve cord has been mounted.

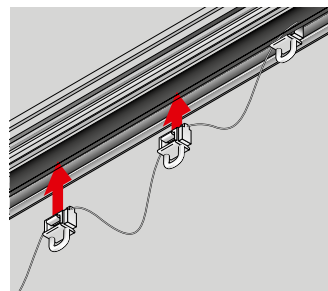

5. Fitting the curtains.

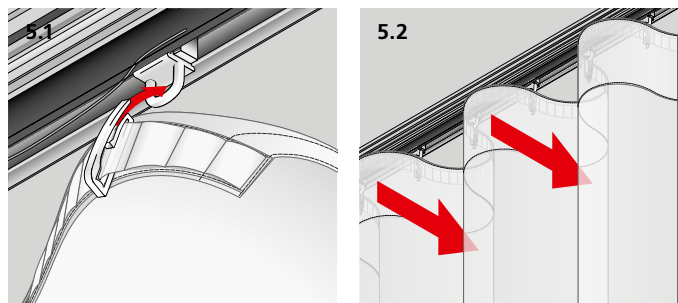

- 5.1 Hold the curtains in such a way that the hook tape is facing the window. Put the outermost hook (HH 9) through the eyelet of the outermost 'Clic glider on the previously mounted 'Curve cord. Put the following hook through the eyelet of the next 'Clic glider – the first wave is already being formed. Keep going until all the hooks have been put through the glider eyelets.

- 5.2 Now press the material between the gliders alternately in front or behind in order to form a perfect wave.

- 5.3 We recommend you use a curtain draw rod to operate the system: Simply use a 'Clic glider to attach the draw rod to the first or last wave.

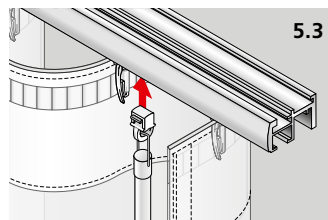

QUALITY: All components are characterised by UV protection, durability and Hinno's tried and tested quality.

CURTAIN MATERIALS: Almost all materials are suitable for hanging as curtains, but we would advise against very stiff materials.

CURTAIN CARE: To wash the curtains, just take the hooks out of the eyelets of the 'Clic gliders and wash them, along with the hooks inserted into the hook tape. We recommend that you use a washing bag. The clean curtains can then be put back on the 'Curve cord as at point 5.



HINNO 

HINNO AG + Blegistrasse 19 + CH-6340 Baar

Phone: +41 (0)41 377 38 77

Fax: +41 (0)41 377 38 60

info@hinno.ch + www.hinno.ch



05_2026_V2

80 mm Ruler

Wave 12 cm 14 cm 16 cm

System components.

The Hinno 'Curve system consists of the following elements:

- 1 The Hinno 'Curve cord fitted with original 'Clic HC 4 gliders (SIXO).
- 2 The Hinno 'Curve pleating tape.
Available with a height of 7.8 cm or 3.8 cm.
- 3 The Hinno 'Curve HH 9 hooks. These are mounted on the 'Curve hook tape and then inserted into the 'Curve gliders on the 'Curve cord.

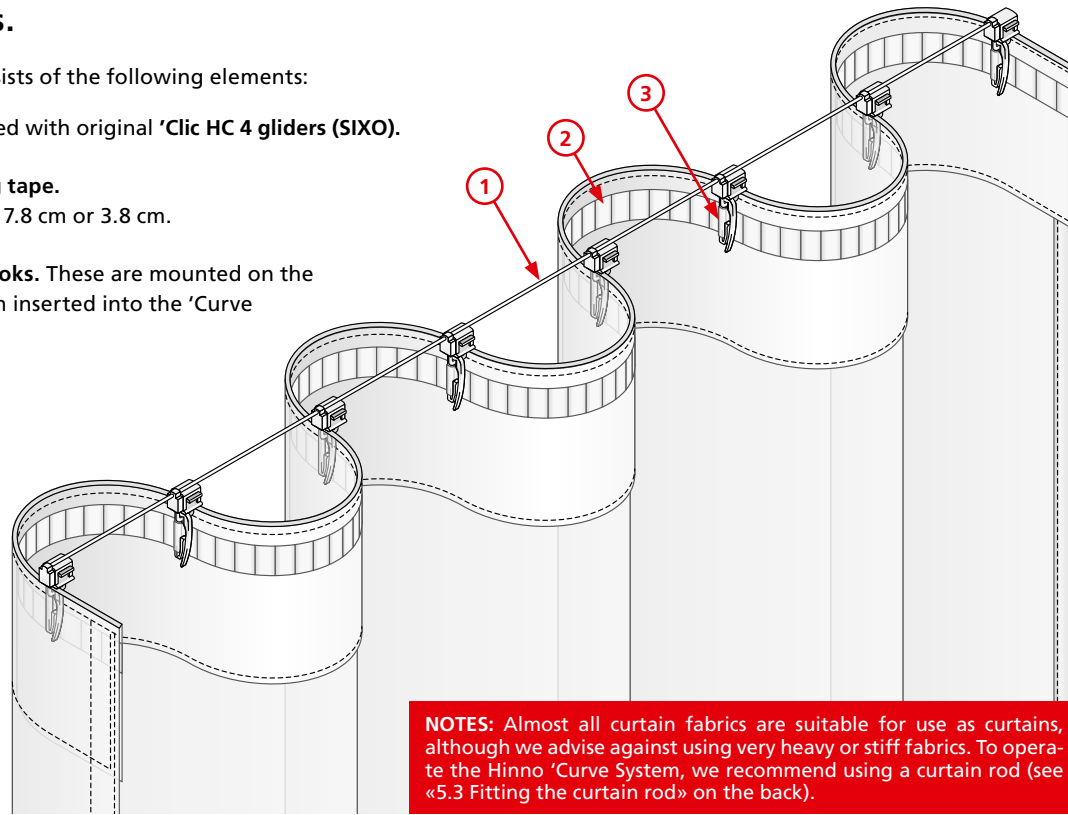
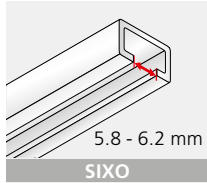

NOTES: Almost all curtain fabrics are suitable for use as curtains, although we advise against using very heavy or stiff fabrics. To operate the Hinno 'Curve System, we recommend using a curtain rod (see «5.3 Fitting the curtain rod» on the back).

Dimensions table.

- Curtain rail
- 'Curve cord

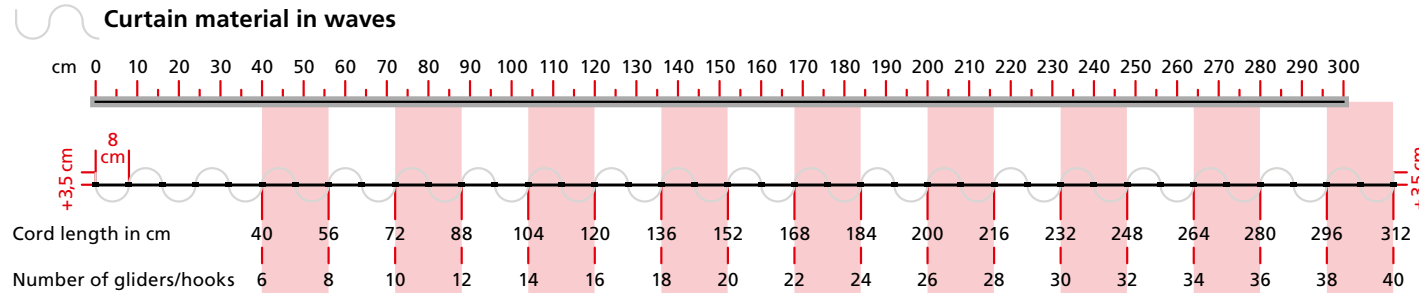

1. RAIL LENGTH.

Rail length	cm	40-56	57-72	73-88	89-104	105-120	121-136	137-152	153-168	169-184	185-200	201-216	217-232	233-248	249-264	265-280	281-296	297-312
-------------	----	-------	-------	-------	--------	---------	---------	---------	---------	---------	---------	---------	---------	---------	---------	---------	---------	---------

2. CORRECT LENGTH OF 'CURVE CORD. (Recommendation: Always round off the cord length to an even number of gliders.)

Cord length	cm	56	72	88	104	120	136	152	168	184	200	216	232	248	264	280	296	312
Gliders/hooks	Qty.	8	10	12	14	16	18	20	22	24	26	28	30	32	34	36	38	40

3. REQUIRED CURTAIN MATERIAL LENGTH. (Specifications include 7 cm for the two ends of the system but do not include additional material for seams'.)

A: 12 cm wave	cm	91	115	139	163	187	211	235	259	283	307	331	355	379	403	427	451	475
B: 14 cm wave	cm	105	133	161	189	217	245	273	301	329	357	385	413	441	469	497	525	553
C: 16 cm wave	cm	119	151	183	215	247	279	311	343	375	407	439	471	503	535	567	599	631

* You need to add the amount of material needed to sew the seams to the overall length.

Calculating how much material you need: (Number of gliders - 1) × wave length + 7 cm = **material required** + the material needed to sew the seams
(14-1) × 16 cm + 7 cm = **215 cm** + material for sewing the seams

1. Determining the length of the 'Curve cord and the material required.

Calculating the dimensions and how much material you will need is easy with the Hinno 'Curve dimensions table:

- 1.1 **MEASURE THE RAIL LENGTH.** First of all, measure the length of your curtain rail.
- 1.2 **DETERMINE THE LENGTH OF THE 'CURVE CORD.** Transfer the length of the curtain rail to the 'Curve cord. Now round up the length so that it equals an even number of gliders on the 'Curve cord. For example: A length of 100 cm would be rounded up to 104 cm (14 gliders). The 'Curve cord would be cut behind the 14th glider. Using an even number of gliders makes the ends of the system face the same way (towards the window) which looks neater.
- 1.3 **CHOOSING THE WAVE SIZE.** We recommend either 12, 14 or at the most 16 cm of material for each wave. Make sure there is enough depth between the curtain rail and the window (e.g.: at least 7.5 cm for a 16 cm wave). Where curtain tracks with integrated screen are used, the distance between the track groove and the screen must be taken into account (e.g. Hinno SB 3 with 14 cm wave and 'Curve cord mounted in the track groove furthest back).

A: Depth of the 'Curve system with a 12 cm wave.

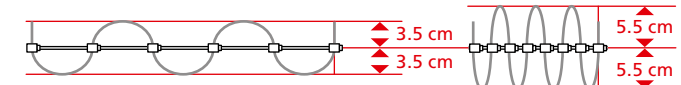

B: Depth of the 'Curve system with a 14 cm wave.

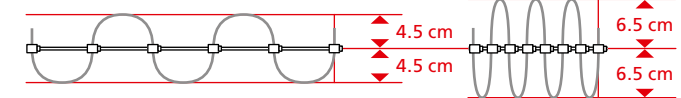

C: Depth of the 'Curve system with a 16 cm wave.

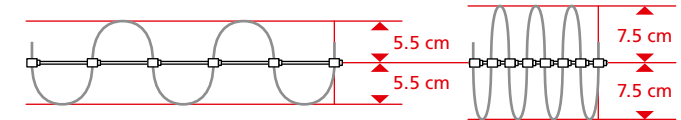

- 1.4 **CALCULATING MATERIAL REQUIREMENTS.** You can use the number of gliders on the 'Curve cord to reference how much material you will need for the chosen wave length (A, B or C) from the dimensions table. The dimensions already include 7 cm for the two ends of the system (3.5 cm at each end). All you have to do is add the amount of material you need to sew the seams.